



essenza

ESPRESSO MACHINES

RAPHAEL MANUAL





Important Safeguards Overview Page 1 of 3

When using electrical appliances, basic safety precautions must always be followed, including the following:

1. Read all Instructions.
2. Check voltage to be sure that the voltage indicated on the name plate is compatible with your voltage.
3. This machine must be connected to a grounded outlet.
4. Close supervision is necessary when the appliance is used by or near children. Place the machine out of the reach of children and persons with limited capabilities.
5. Do not place the machine close to a fire source to avoid any damage.
6. Unplug from outlet when not in use and before cleaning. Allow to cool before putting on or taking off parts, and before cleaning the appliance.
7. The appliance should be placed on table or flat place. Do not place the machine on the edge of desk or table.
8. Some parts temperature will be very high when machine is working, example steaming pipe, steaming nozzle, funnel holder. Do not touch any hot parts to avoid scald.
9. To protect against fire, electric shock and injury to persons, do not immerse cord, plugs, or body of machine in water or other liquid.
10. Once the fault, defect or machine drop caused by suspicious defect, unplug the power plug immediately, do not operate on the problem machine.
11. Do not operate any appliance with a damaged cord or plug or after the appliance malfunctions, or has been damaged in any manner. Return appliance to the nearest authorized service facility for examination, repair or adjustment. If the SUPPLY CORD is damaged, it must be replaced by the manufacturer, its service agent or similarly qualified persons in order to avoid a hazard.
12. Do not put the machine in an environment where the temperature is below zero, because there is residual water in the Boilerr and pump, which will damage the machine when it turns into ice;
13. Do not use outdoors.



Important Safeguards Overview Page 2 of 3

14. The appliance must not be immersed on water or other liquid.
15. Potential injury from misuse
16. The heating element surface is subject to residual heat after use.
17. Cleaning and user maintenance shall not be made by children without supervision.
18. The coffee-maker should not be placed in a cabinet when in use.
19. This appliance can be used by children aged from 8 years and above if they have been given supervision or instruction concerning use of the appliance in a safe way and if they understand the hazards involved. Cleaning and user maintenance shall not be made by children unless they are older than 8 and supervised. Keep the appliance and its cord out of reach of children aged less than 8 years.
20. This appliance is not intended for use by persons (including children) with reduced physical, sensory or mental capabilities, or lack of experience and knowledge, unless they have been given supervision or instruction concerning use of the appliance by a person responsible for their safety. Children should be supervised to ensure that they do not play with the appliance.
21. Do not touch hot surfaces. Use handles or knobs.
22. The use of accessory attachments not recommended by the appliance manufacturer may result in fire, electric shock or injury to persons.
23. Do not let cord hang over edge of table or counter, or touch hot surfaces.
24. Do not place on or near a hot gas or electric burner, or in a heated oven.
25. Always attach plug to appliance first, then plug cord into the wall outlet. To disconnect, turn any control to "off," then remove plug from wall outlet.
26. Only use porta filter intended for this appliance. If the capsule does not fit, do not force the porta filter into the appliance.
27. **WARNING:** To avoid the risk of injury, do not open the brew chamber during the brew process.
28. Do not use appliance for other than intended use.
29. **WARNING:** The filling aperture shall not be opened during use.



Important Safeguards Overview Page 3 of 3

a) A short power-supply cord (or detachable power-supply cord) is provided to reduce risks resulting from becoming entangled in or tripping over a longer cord. b) Longer detachable power-supply cords or extension cords are available and may be used if care is exercised in their use. c) If a long detachable power-supply cord or extension cord is used: 1) The marked electrical rating of the detachable power-supply cord or extension cord should be at least as great as the electrical rating of the appliance; 2) If the appliance is of the grounded type, the extension cord should be a grounding-type 3-wire cord; and 3) The longer cord should be arranged so that it will not drape over the counter top or table top where it can be pulled on by children or tripped over.

- This instruction can also get from www.essenza-espresso.de

- **SAVE THESE INSTRUCTIONS**

- **Machine use condition:**

- Voltage: **AC 220V-240V 50/60Hz**; single phase
- Water: Pure water and distilled water cannot be used. Use the softened water
- Room temperature: 0°C - 55°C

INTRODUCTION

Dear valued coffee enthusiast,

Welcome to the world of Essenza, where passion for coffee meets precision engineering. We extend our heartfelt gratitude for choosing our meticulously crafted Espresso machine. Designed in Germany and hand-manufactured, Essenza products embody a perfect blend of tradition, expertise, technological advancements, and uncompromising quality.

Our commitment revolves around the simple yet profound goal of enabling you to savor the finest coffee experiences. Whether you're a seasoned connoisseur or just embarking on your coffee journey, Essenza is here to elevate your coffee moments.

In the rare event that you encounter any issues or have questions about your Essenza product, please don't hesitate to reach out to your trusted Essenza dealer or contact us directly. Your satisfaction is our priority, and we are dedicated to ensuring that your coffee journey remains seamless and delightful.

For additional information on our products and accessories, please visit our website at www.essenza-espresso.de. Explore the world of Essenza and discover a range of offerings that complement your coffee passion.

Thank you for choosing Essenza – where tradition, innovation, and the pursuit of excellence converge to bring you the finest in coffee enjoyment.

Sip, savor, and enjoy every moment.

Warm regards,

Your Alexander Lösch
Head of Research and Development

CONTENT

About these instructions	5	Understand the display and change settings	17
Described products	5	The LCD display	17
Symbols and abbreviations used	5	The pre-brewing time	17
Safety and warning notices	5	The Boilerr temperature	18
		The ECO-Mode	18
Important safety instructions	6	Clean the machine	19
Intended Use	7	Cleaning after each use	19
Improper Use	7	Regular cleaning	19
		Measures before long periods of non-use	21
Get to know the machine	9	Cleaning after long periods of non-use	21
Unpacking	9		
Scope of delivery	9	If something does not work	23
Overview of the machine	10		
		Maintain and repair the machine	25
Set up and connect the machine	11	Change shower screen	25
Set up the machine	11	Descale the machine	26
Start the machine for the first time	11	Warranty	28
Connect the machine electrically	12	Customer service / Repair	28
Prepare the machine	12	Spare Parts	28
		Technical details	29
Start up and operate the machine	13	Non-use / Disposal / ETL-Conformity	31
Notes on preparing coffee	12	Disposal	31
Making coffee	14	ETL- Conformity	31
Frothing	15		
Remove hot water	16		
Turn off the machine	16		



essenza

ESPRESSO MACHINES

RAPHAEL



ABOUT THIS MANUAL

- Read these instructions carefully and follow all instructions given.
- Keep these instructions close to the machine.
- If there is a change of owner, pass on the instructions with the machine.

Described products

These operating instructions apply to the following product: **Raphael**

Representation conventions

Actions

Individual actions are marked by a preceding triangle:

- Individual instruction

Actions that have to be carried out in a certain order are numbered:

1. Step 1
2. Step 2
3. Step 3

Symbols and abbreviations used



Here you will find important or interesting information about the product and its operation

Safety and warning notices

Safety and warning notices protect you and your machine. You should therefore read this information carefully and follow the instructions given.

Structure of warning notices

The warning notices are structured according to the following scheme:

WARNINGWORD

The nature and source of the danger

Consequences if the measures to avoid the danger are not observed.

- Measures to avoid the danger.

Meaning of the warning words

- **DANGER:** Damage to or destruction of the product
- **ATTENTION:** Minor or moderate injuries
- **WARNING:** Serious injury or death

IMPORTANT SAFETY INSTRUCTIONS

When setting up

- Check the mains voltage available at the installation site and only start up the machine if it corresponds to the voltage range specified on the nameplate.
- Lay the connection cable so that nobody can trip over it and it does not come into contact with sharp or very hot objects.
- Only connect the machine to an earthed socket. If you are unsure, contact an electrician.
- Do not set up the device near strong heat or fire sources to avoid damage.
- Set up the machine on a level and stable surface. Avoid unsafe documents that can tip over or be knocked over while walking by.
- Set up the machine out of the reach of children and people with limited abilities.

During commissioning

- Do not operate the machine if the device or the power cord are damaged. In this case, contact your specialist dealer or contact Emma.

Operational

- During operation, some machine parts such as the brew group or the steam pipe and the steam nozzle are very hot. Do not touch these parts during operation to avoid burns.
- Switch the machine off immediately and pull the power plug out of the socket if the power cord is damaged. Be careful not to touch the damaged area. Contact your specialist dealer and have the defective cable replaced. Do not put the machine back into operation until the damage has been properly repaired.
- Children from the age of 8 and people with limited physical, sensory or mental abilities may only operate the machine after receiving appropriate instruction. If necessary, supervise the persons while operating the machine.

For cleaning and maintenance

- Before cleaning and maintenance work:
 - Let the machine cool down.
 - Disconnect the machine from the mains voltage.
- Only use a damp cloth to clean the machine. Do not immerse the machine in water or other liquids.

IMPORTANT SAFETY INSTRUCTIONS

- Cleaning and maintenance must not be carried out by children or persons with restrictions without supervision.

When not in use for a long time

- Disconnect the machine if it is not going to be used for a long time (e.g. before a vacation) from the mains voltage.
- Check the machine and power plug for damage after a long period of non-use and only operate the machine if it is undamaged.

Intended Use

- The machine may only be used indoors.
- The machine is suitable for private and business use. Possible places of use are e.g.
 - private households
 - Staff kitchens in shops, offices and companies
 - Hotels, motels and boarding houses
- When using the machine in a business environment, people must be instructed in its operation and informed about the possible dangers before using it.
- The machine may only be used within the permissible temperature range (see technical data). If there is a risk of frost, the water in the Boiler must be drained off.

Improper use

- The machine must not be used outdoors.
- The machine must not be used in environments in which the permissible environmental conditions e.g. B. for temperature and humidity are exceeded.



essenza

ESPRESSO MACHINES

RAPHAEL



GET TO KNOW THE MACHINE

Unpacking

1. Open the packaging and remove all parts.
2. Check all parts for completeness and damage. If parts are missing or damaged, please contact your specialist dealer.
3. Keep the packaging, e.g. for a later transport or a possible sending for a repair.

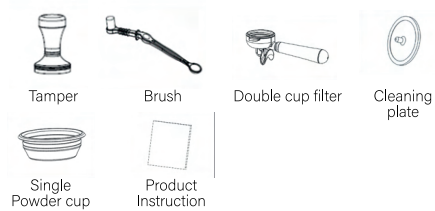
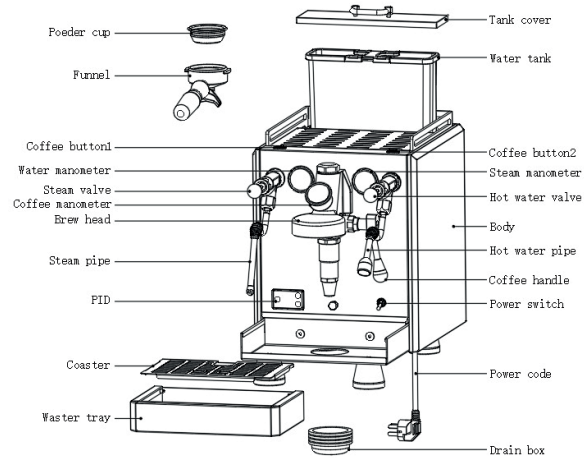

Fig. 1: The picture shows Raphael



OVERVIEW OF THE MACHINE



Fig. 1: The picture shows Raphael

Drip tray: Excess water is collected there and has to be drained occasionally.

Cover plate for the drip tray

Display: For viewing and changing settings

Steam pipe with nozzle: To extract steam e.g. for frothing milk

Pump pressure display: Shows the pressure of the pump in bar

Steam valve: To regulate the output

Cup warmer

Cup rail: For safe storage of cups

Hot water pipe with nozzle: For dispensing hot water e.g. for the preparation of tea

Control buttons

Hot water, single cup, double cup, custom cup

On / Off switch / SET Button

Water tank: Note the specified filling heights (not shown)

SET UP AND CONNECT THE MACHINE

Open the machine

- Turn on the power switch;
- Machine will pump the water automatically and hear the sound of pump working.
- After finish pump up the water, the machine inside will start preheating, the display will show the Boilerr preheating temperature. The steam manometer will also goes up when under preheating.
- When heating to the setting temperature, the machine inside will stop preheating.
- For the first time or when the display shows the Boilerr temperature is 25 degree, the preheating time will be approx. 15mins.

Note: Even the preheating is not finish, the machine can also make coffee, but the coffee or hot water temperature will be low.

Manual making coffee

Note: If the coffee powder is too fine it would cause the coffee can not come out.

If the coffee powder is too much, it would cause the porta filter holder can not be fixed and coffee will be leakage from the edge of holder.

Please do not touch the hot surface to avoid scalded.

- Put the coffee powder to the filter and press.
- Lock the filter holder counterclockwise into the middle of the brew head (must be tightened);
- Put the coffee cup under the filter.

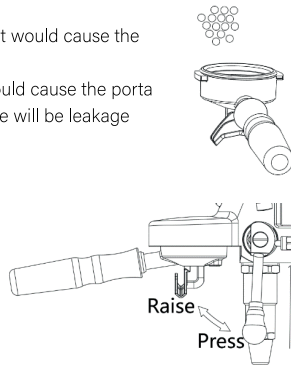

- Raise the handle,when the coffee amount comes out as you need, press down the handle, the coffee will stop.
- Remove filter holder after finished, knock it out and clean it with hot water immediately, and lock it again for next use.

Automatic making coffee

Note: If the coffee powder is too fine it would cause the coffee can not come out.

If the coffee powder is too much, it would cause the porta filter holder can not be fixed and coffee will be leakage from the edge of holder.

Please do not touch the hot surface to avoid scalded.

- Put the coffee powder to the filter and press.
- lock the filter holder counterclockwise into the middle of the brew head (must be tightened);
- Put the coffee cup under the filter.
- Press coffee button 1 or button 2, The machine will start making coffee, and when the coffee making time set by the button is reached, the machine will automatically end the coffee making.
- Remove filter holder after finished, knock it out and clean it with hot water immediately, and lock it again for next use.



Making hot water

- When the steam manometer show the digital more than 0, Turn the hot water valve lever in either direction, the hot water will come out.



SET UP AND CONNECT THE MACHINE

- When finish making hot water, Reset the hot water valve lever and stop making hot water.

Note: When finish making hot water, please do not touch the hot water pipe immediately to avoid scalded. When move the hot water pipe, please hold the black handle part

Note: When making hot water, if the temperature displayed on the display is less than 100 degrees, the speed of hot water may be reduced or even no hot water can be produced.

Note: It is recommended that the production of hot water should not be too long, if the production of hot water for a long time, the steam pressure value will drop rapidly, and the effect of making steam will be affected in a short time.

Making steam

- When the PID show the temperature value more than 100, Turn the steam valve lever in either direction, the steam will come out.
- When finish making steam, Reset the steam valve lever and stop making steam.

Note: The temperature is very hot on the surface of steam pipe, please do not touch to avoid scalded. When move the steam pipe, please hold the black rubber on the steam pipe.

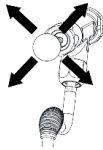

Turn off the machine

- Turn off the power switch can turn off the machine.
- When the machine is turned off and no use, please also turn off the external power supply.



- If the machine need transportation or long time no need to use, please drain the water from Boilerr, Please refer to 4.7.

Antifreeze steps

Note: in order to prevent the water in the Boilerr get freezing and causing the Boilerr to crack, when using the coffee machine where the room temperature will be lower than the freezing point temperature, the following anti freezing steps must be followed before shutting down the coffee machine every day,

- Turn off the power switch when the machine is hot;
- Turn the lever of the hot water valve in either direction and release the hot water until no water flows out;
- Hold down the coffee 1 button for 3 seconds and lift the coffee handle at the same time. The light of key 1 will flash and the machine will enter the automatic drainage mode. When the button 1 light is off, the automatic drainage mode ends;
- Take out the water tank and empty the remaining water inside.

START-UP AND OPERATE THE MACHINE

Notes on preparing coffee

Your espresso machine was developed for the ultimate in coffee enjoyment. In addition to the quality of the machine, the following points are important for the correct coffee preparation:

The water quality

- Always use fresh, softened water.
- Replace the water in the water tank if you are not going to use the machine for a long time.

The operating temperature

- After switching on, wait until the entire machine including the inserted, empty portafilter has reached the optimum operating temperature. This takes about 10 minutes.

The coffee quality

- Use high quality coffee as possible.
- For the best taste, buy whole coffee beans and grind them yourself.

Correct grinding and tamping

- Always grind fresh immediately before preparing coffee. Also pay attention to the quality of the coffee grinder. At Essenza you will find suitable high-quality coffee grinders.

- In addition to the water temperature, the degree of grinding and the amount of powder are decisive for the best taste. Please refer to the instructions for your coffee grinder. Experiment with the settings: Start with a medium grind and select around 7 g of powder for the single portafilter or 14 g for the double portafilter.
- If the coffee runs too quickly and too thinly, select a finer grind. If the coffee is dripping and is very dark in color, select a coarser grind.
- Press the powder ground in the portafilter a little with the tamper included in the scope of delivery. To do this, develop a medium pressure that is as even as possible. Grind and tamper pressure work together and have a strong influence on the quality of the taste and crema.



The crema is the creamy layer on the espresso surface. Color and consistency are a measure of the correct preparation. The crema should have an even, light brown color. To test the consistency, some sugar should sink after a few seconds.

START UP AND OPERATE THE MACHINE

Making coffee

ATTENTION

Risk of burns

Parts of the machine, in particular the brewing group and portafilter as well as the steam and hot water pipes, are very hot during operation. There is a risk of burns if touched!

- Do not touch these parts while they are hot. Only grasp the portafilter by the insulated handle.

The machine is connected to the power supply,

- ✓ The water tank is filled.
- ✓ The valves for steam and water extraction are closed.
- ✓ The coffee dispensing is off (lever in the down position).

1. Insert the empty portafilter.
2. To do this, insert the empty portafilter for single or double use, rotated approx. 45° to the left from below into the brewing group and turn it to the right until you feel a resistance. Screw in tight but not too tight!
3. Switch the machine on using the on / off switch (Figure 2: 11).
 - The machine now audibly pumps water out of the watertank into the Boilerr. When switching on for the first time, this can take some time as the Boilerr is still completely empty. It may also be necessary to top up with water.
 - As soon as the Boilerr is filled, the pump stops and the Water is heating up.

- The display (Fig. 2: 3) shows the current Boilerr temperature. When the machine is switched on while it is still cold, this corresponds approximately to room temperature.

4. Wait for the machine to reach operating temperature. This takes about 5 minutes. The display now shows the preset temperature of 93°C.

It is also possible to prepare coffee before the desired Boilerr temperature has been reached. However, because the water temperature is too low, the result will not be satisfactory.

5. Loosen the portafilter by turning it approx. 45 ° to the left, fill in the coffee powder, compress it with the tamper and reinsert the portafilter.
6. Place one or two cups (depending on the desired cover) under the portafilter and push the buttons for the amount of coffee you want (single cup, double cup or custom cup).
 - The coffee runs after the preset pre-brewing time
7. As soon as the configured amount of coffee has been reached the machine will stop dispensing.

START UP AND OPERATE THE MACHINE

Frothing

ATTENTION

Risk of burns

The steam pipe, nozzle and escaping steam are hot. There is a risk of burns if touched!

- Do not touch the steam pipe or nozzle during operation. Only operate the valve lever to extract steam.
- Avoid skin contact with the escaping steam. Also, watch out for hot splashes.



Milk foam is used to make beverages such as cappuccino or latte macchiato. When the frothing starts, hold the steam nozzle close to the surface of the drink to blow some air. Then dip the nozzle all the way into the drink until it has a creamy consistency. Do not try to create as much foam as possible and do not let the drink get too hot. Otherwise taste and consistency lose quality. Large air bubbles in the foam are a sign that too much air has been used.

1. Pour milk (or another beverage of your choice) into a sufficiently large container. The vessel should be about twice as high as the drink filled.
2. Open the steam lever by moving it up or down and let the water come out first until only steam is coming.
3. Close the valve again.
4. Immerse the steam pipe in the drink, push the steam button again and prepare the foam in the desired quantity and consistency (see INFO box on the left).
5. Push the steam button again, clean the steam lance and jet with a damp cloth and push the steam button again to blow out any residue in the steam pipe.
6. Push the steam button for stop.
7. Pour the milk foam into a e.g. cup filled with an espresso. By withdrawing a larger amount of steam, the steam pressure can briefly drop slightly. The machine starts reheating immediately, so that the pressure quickly rises to its initial value.

Turn on/off the steam function

- If steam is not required, the user can turn off the steam function.
- Hold the Minus button on PID for 3 seconds and the steam function will be turned off or on. When the steam function is turned off, the steam key light will not light up.

START-UP AND OPERATE THE MACHINE

Get hot water

ATTENTION

Risk of burns

The hot water pipe, nozzle and dispensed water are hot. There is a risk of burns if touched!

- Do not touch the hot water pipe or the nozzle during operation.
- Avoid skin contact with the hot water. Also, watch out for hot water splashes.



You can use the generated hot water e.g. use for the preparation of tea or Caffé Americano (espresso with additional hot water).

1. Hold a receptacle under the hot water nozzle and push the hot water button. More details about the configuration you can find on page 11.

The water taken from the Boilerr is immediately refilled from the water tank. The withdrawal of a larger amount of water can therefore lead to a drop in the Boilerr temperature. You may need to top up with water.

Turn off the machine



With the ECO mode, the machine switches itself off automatically if it is not operated for a certain period of time. In the delivery state, the ECO mode EC1 is set, which means that the machine switches off after 35 minutes. When ECO mode is active, the display shows EC1. For more information, see section "The ECO mode" on page 17.

1. Switch the machine off at the on / off switch if you do not want to make any more coffee or if you no longer need steam or hot water.
2. Remove the portafilter, knock it out and clean it under hot water. However, do not use it until your next use so that the rubber seal is not permanently under pressure and the sieve in the brew group can dry out.

UNDERSTAND THE DISPLAY AND CHANGE SETTINGS

Basic Operation

After the boot, by pressing the key **SET** on the display screen, you can switch between the following Settings, switch to the last item, and then press the key **+** to exit the setting mode;
After selecting a setting, press the "+/-" key on the display screen to adjust the parameter.

Pre time

- Press the key **SET**. When "P1" is flashing , If you press any of the "+/-" buttons, the pre-infusion time adjustment mode is entered.
- Press the +/- key to select the parameters. The value ranges from 0-30 seconds . The default value is 5.

Ramp time

- Press the key **SET**. When "P2" is flashing , If you press any of the "+/-" buttons, the ramp time adjustment mode is entered.
- Press the +/- key to select the parameters. The value ranges from 0-15 seconds . The default value is 5.

Steam temperature

- Press the button key **SET** continuously, When "A1" is flashing , If you press any of the "+/-" buttons, Activate this parameter setting
- you can press "+/-" to adjust the temperature, the temperature range will be 100-135°C. The default value is 125°C.

Coffee temperature

- Press the button key **SET** continuously, When "A2" is flashing , If you press any of the "+/-" buttons, Activate this parameter setting
- you can press "+/-" to adjust the coffee temperature, the temperature range will be 80-98°C. The default value is 92°C.

ECO mode

- Press the button key **SET** continuously, When "ECO" is flashing, If you press any of the "+/-" buttons, Activate this parameter setting
- you can press the "+/-" to choose . the time range will be 0-180 minutes. The default value is 30.
- If the value is 0, the energy saving function is disabled
- When the machine goes to ECO mode, the display will show ECO(all the electricity will off), press any key again, the machine starts working again.

Water Settings

- Press the button key **SET** continuously, When "F" is flashing, If you press any of the "+/-" buttons, Activate this parameter setting
- You can press the "+/-" key to select parameters. Two modes are available: F0 or F1. The default value is F0.
- F0: Use water tank for water supply;
- F1: Use outside water. If you want to use outside water, use the water

UNDERSTAND THE DISPLAY AND CHANGE SETTINGS

pipe to connect the outside water to the inlet port, and also need to turn the water valve at the bottom of the machine to face the rear.

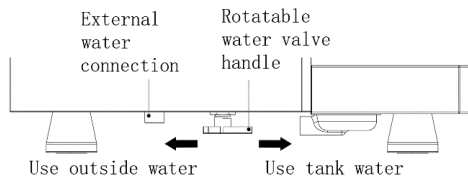

Time setting for coffee 1

- Press the button **SET** continuously, When "C1" is flashing , If you press any of the "+/-" buttons, Activate this parameter setting
- you can press "+/-" to adjust the time for coffee 1, the time range will be 15-120 seconds. The default value is 30.

Time setting for coffee 2

- Press the button **SET** continuously, When "C2" is flashing , If you press any of the "+/-" buttons, Activate this parameter setting
- you can press "+/-" to adjust the time for coffee 1, the time range will be 15-120 seconds. The default value is 40.

Temperature display adjustment

- Under the startup state, users can press the "+,/" button to view the real-time temperature of the steam Boiler and coffee Boiler;

- Press "+" to display the temperature of the steam Boiler.
- press "-", to display the temperature of the coffee Boiler.

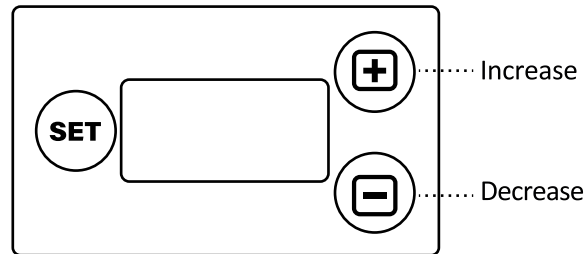

CLEAN THE MACHINE

So that you can enjoy your Essenza espresso machine over the long term and the coffee tastes consistently good, here are a few tips for cleaning the machine.

Cleaning after each use

- Wipe the steam pipe and nozzle with a damp cloth after each frothing.
- Immediately after wiping the pipe, open the steam valve again to blow any residue out of the pipe.
- Tap the portafilter after switching off the machine, rinse it with hot water and place it on the sheet of the water collecting tray.

Regular cleaning

Clean the water tank

Even if you always use fresh, softened water, you should clean the water tank at regular intervals.

1. Remove the tank and empty out any remaining water.
2. Clean the tank with commercially available detergent. Make sure that no detergent residue is left behind.
3. Put the tank back down and fill it with fresh, cold water.

Clean the drip tray

The excess water from the brewing unit is collected in the drip tray.

1. Check the water level in the drip tray regularly. A full drip tray is not displayed.
2. Pull out the drip tray forwards and empty the contents.
3. **CAUTION:** If the drip tray is filled to the brim, the water it contains can spill over. Then use a container to remove a certain amount before pulling out the drip tray all the way.
4. Clean the drip tray, dry it and put it back in place.
5. If necessary, also clean the cover plate.

CLEAN THE MACHINE

Clean the shower screen and group seal

The shower screen is located in the portafilter holder of the brew group. The shower screen presses on the powder compacted in the portafilter and distributes the water pressed in with pressure evenly over the powder surface. Constant contact with the coffee powder can contaminate the sieve and seal and should therefore be cleaned at regular intervals.

1. Remove the portafilter and place a container under the brew group.
2. Use the brush included in the scope of delivery to remove coffee residues and encrustations from the sieve.
3. Use the custom cup button to start the pump to rinse out the brushed-off parts.



- Depending on the frequency of use, the shower strainer and group seal should be replaced after a few years. Information on this can be found in the section "Changing the shower filter and group seal" on page 25.

Clean the housing

⚠ WARNING

Electric shock

Liquids that get into the machine can cause a short circuit and electric shock. Serious injuries and damage to the machine can result.

- Only clean the machine when it is switched off. Also disconnect the machine from the power supply.
- Make sure that no liquids get inside the machine.
- If liquids got inside the machine during cleaning, do not connect the machine to the power supply and do not switch it on. Depending on the amount of liquid that has entered, wait until it has evaporated again. Contact your specialist dealer if you are not sure.

⚠ ATTENTION

Risk of burns

Parts of the machine can still be hot even after switching off. There is a risk of burns if touched!

- Only clean the machine when it is switched off.
- After switching off the machine, wait until all parts have cooled down sufficiently.

⚠ DANGER

Unsuitable cleaning agents

Unsuitable cleaning agents can scratch or damage the housing.

- Only use a soft, slightly damp cloth (e.g. microfiber cloth).
- You can use a cleaning agent specially designed for stainless steel surfaces if it is heavily soiled.
- Never use scouring agents, agents with cleaning bodies, sponges with scouring surfaces or wool.

Clean the housing

1. Switch off the machine and disconnect it from the power supply.
2. If necessary, wait until all housing parts have cooled down.
3. Wipe the housing with a soft, slightly damp cloth (e.g. microfiber cloth).

Measures before long periods of non-use

If it is foreseeable that the machine will not be used for a longer period of time, recommends the following measures:

1. Switch off the machine and disconnect it from the mains voltage.
2. Remove the water tank, empty and clean it.

3. Empty the Boilerr completely. To do this, open the water drain screw on the underside of the machine. Screw the screw back in when the water has drained. After this measure, the machine can also be stored below freezing point.

ATTENTION! Do not store the machine below freezing point with a filled kettle. This can destroy the Boilerr.

4. Remove the portafilter from the brew group, clean it and place it on the shelf.

Cleaning after long periods of non-use

Clean the water tank

- Empty the water tank, clean it and refill it completely.

Replace the Boilerr water

If the machine has not been used for a long time, the water in the Boilerr should also be replaced.

1. Fill the water tank with fresh water and switch on the machine.
2. Withdraw water through the hot water pipe.
3. Repeat the process until the water tank has been completely emptied.
4. Fill the water tank again.



essenza

ESPRESSO MACHINES

RAPHAEL



IF SOMETHING DOES NOT WORK

Problem	Cause	Solution
Turn on the machine and always pumping water	No/lack of water in the water tank	Refill the water
	The drain water valve is open, the water comes out	Close the drain water valve
	Machine malfunctions	Please contact with the authorized service
Coffee overflow from the edge of funnel seal	Too much coffee powder in filter	Clean the filter, then pour appropriate coffee powder
	Coffee powder remained in the seal under group head	Clean the seal under group head
	The seal ring is broken	Change the seal ring
No hot water comes out	Machine is under pre-heating, temperature is low and pressure is also low	Wait until the preheating is finished
Water leakage on the table	Connector is leakage	Change the connector or seal ring

IF SOMETHING DOES NOT WORK

Problem	Cause	Solution
	Leakage from the inside of machine	Please contact with the authorized service
No coffee comes out	Coffee powder is too fine, with maximum pressure still no coffee comes out	Use more coarse coffee powder
	Machine inside broken	Please contact with the authorized service
No steam comes out	Machine is under pre-heating, temperature is low and pressure is also low	Wait until the preheating is finished
	Steam spout is blocked	Turn off the steam spout clean or change it
Display show E30	Lack of water from water tank or not put it in correct position	Refill the water and check the position
Display show E01/E02	Ambient temperature is too low	Place the machine in a warm environment for 2 hours before use
Display show E11/E12	Temperature sensor anomaly	Contact professional maintenance personnel
Display show E31	The pump continuously pumps water for a long time	Turn off the power switch and turn it on again/Check whether the pipe is abnormal/contact professional maintenance personnel
Display show E21/E22	The continuous working time of the heating element is too long	Check that the steam handle and hot water handle are closed Contact professional maintenance personnel

Note: If you have not been able to solve the problem, contact customer support in your country.

MAINTAIN AND REPAIR THE MACHINE

Repairs may only be carried out by authorized specialists. If you carry out repairs yourself during the guarantee period, any claim to the guarantee is void.

However, you can carry out minor service work yourself. Which includes:

- Change shower screen
- Descale the machine
- If you do not want to carry out these activities yourself, please contact your specialist dealer. He will be happy to help you

Change shower strainer and group seal

The shower screen and group seal should be cleaned regularly. You can find information on this in the section "Cleaning the shower strainer and group seal" on page 20.

However, depending on the frequency of use, the shower screen and group seal should be replaced after a few years.

- Place a screwdriver on the sieve and lever it out together with the seal.



- Clean the brew group with the brush.

- Slide the new seal with the rounded side up over the sieve and press both parts firmly into their original position.



- To push in the seal and sieve all the way in, put on the sieve holder and tighten completely.



MAINTAIN AND REPAIR THE MACHINE

Descale the machine

DANGER

Operation of a heavily calcified machine

Heavy calcification can impair the functionality of the machine. Lime particles loosening can also block lines and damage the machine.

- Use softened water to slow down calcification.
- Descale your machine regularly, as long as there is no heavy limescale residue.
- Have your specialist dealer decalcify a heavily calcified machine.

DANGER

Descaling a machine that is already calcified

A machine that is already heavily calcified must not be descaled using the method described below. Lime pieces that come off could clog lines and damage the machine.

- Use the method described below to descale your machine only as a preventative measure against scaling.
- Have your specialist dealer decalcify a heavily calcified machine.

Descale the machine as a preventative measure

✓ Have the following ready:

- Portafilter with blind sieve (included in delivery)
- Descaling liquid (available from specialist retailers)
- A medium-sized vessel (for drawing water)

✓ There is no portafilter inserted.

1. Heat up the machine until it has reached operating temperature.
2. Turn off the machine.
3. Place a vessel under the hot water outlet and open the valve to empty the water from the kettle. Close the hot water valve again when no more water comes out.
4. Remove and empty the water tank, mix a suitable descaling agent with water as specified, fill the water tank with it and put it back in.
5. Turn on the machine.
 - The Boiler is filled with the descaling liquid.
6. Push the dispensing lever up and wait for liquid to come out of the brew group.
 - The heat exchanger was then filled with the descaling liquid.
7. Set the hot water lever vertically to switch off the pump.

MAINTAIN AND REPAIR THE MACHINE

8. Place the portafilter with the inserted blind filter in the brew group and set the reference lever horizontally.

- The pump now works against the resistance of the blind sieve.

9. After about 20 seconds, return the reference lever to the vertical position to stop the pump.

- The remaining water is in on the underside of the brew group the drip tray delivered.
- This process decalcifies the expansion valve.

10. Repeat steps 9. + 10. three times.

11. Then let the descaling agent work for about 30 minutes.

12. Remove the portafilter and push the custom cup button to allow the remaining descaling agent from the water tank to run through the brew group.

13. Switch off the machine as soon as the water tank is empty and place the reference lever vertically.

14. Unscrew the nozzle (aerator) on the hot water pipe.

ATTENTION! The pipe and aerator are hot! Use gloves or a cloth.

- This prevents limescale deposits from collecting in the aerator.

15. Place a receptacle under the hot water outlet and push the hot water button to empty the water from the kettle. Release the button again when no more water comes out.

16. Remove the water tank, clean it thoroughly and fill it with fresh water again.

17. Turn on the machine.

- The kettle is filled with the fresh water.

18. Top up with water if necessary.

19. To remove residues from the expansion valve, repeat steps 8 - 10.

20. Take off the portafilter and remove the blind sieve as it is no longer needed. The following steps can be performed with or without the portafilter attached.

21. Set the water level horizontally and after approx. 1 minute vertically again.

- This flushes the heat exchanger through.

22. Repeat the following procedure at least five times until clear, neutral-smelling water comes out of the hot water outlet:

- Switch off the machine when the operating temperature is reached.
- Place a receptacle under the hot water dispenser, open the valve and close it again when no more water comes out.
- If necessary, fill the water tank with fresh water and switch on the machine.

23. Set the dispensing lever horizontally and rinse until clear water also comes out of the brew group.

24. Your machine is now ready for operation again.

MAINTAIN AND REPAIR THE MACHINE

Warranty

Essenza gives a one year warranty.

Structural changes to the machine and repairs that are not carried out by an authorized service partner will void any warranty claims.

Any work on the machine such as maintenance, customer service, repair or replacement of components may only be carried out by authorized service partners.

You can find information on sales partners, service centers and authorized repair centers on the Essenza website at:

www.essenza-espresso.de

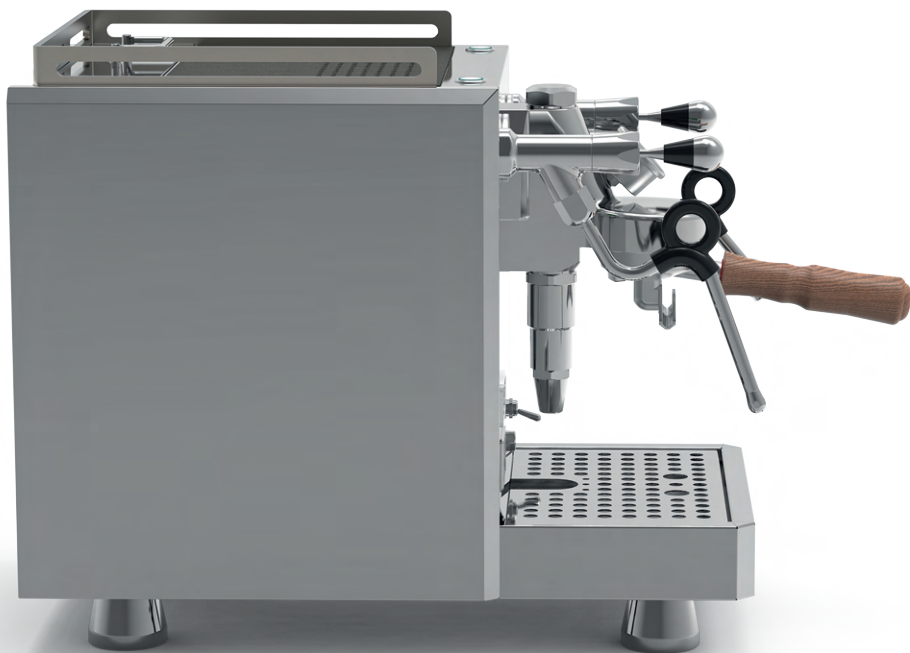

Model	Raphael
Voltage	AC220-240V
Frequency	50Hz/60Hz
Power	2350W
Tank capacity	2L
Pump pressure	15Bar



essenza

ESPRESSO MACHINES

RAPHAEL



NOT USE / DISPOSAL / CE-CONFORMITY

Disposal

This product contains valuable materials that can be recycled. Therefore, at the end of its service life, dispose of the product in an environmentally friendly manner and in accordance with national regulations.



CE-Conformity

This product is CE-compliant and complies with the applicable guidelines and standards.





Eszenza Espressomaschinen GmbH
Rudolf-Diesel-strasse 11
69115 Heidelberg
Germany